

VEROTEC

Electronics Packaging

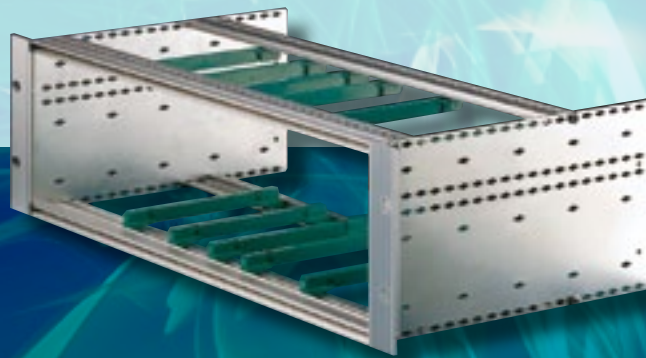
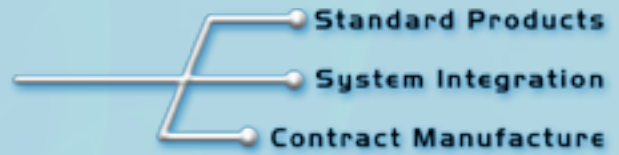

KM6-EC Subracks

Introduction: KM6-EC Subracks

INTRODUCTION

KM6-EC subracks have been designed and are suitable for high volume, cost sensitive applications. Whilst they are still versatile and fully conform to the requirements of IEC60297, care has been taken to remove certain features found in the KM6-II range to reduce the manufacturing cost. These include lighter extrusion profiles, single-point tiebar fixings (rather than double) and Zintec side plates (rather than aluminium).

FEATURES

- Lightweight and versatile economy range, supplied in kit form for simple yet accurate assembly
- EMC conversion options
- Conductive finish
- Backplane mounting or DIN 41612 connectors.
- Compatible with certain accessories from the KM6-II range
- EC universally pierced end plates

BACKPLANE EXTRUSIONS

Type 1 is a normal version which requires a backplane spacer strip, either insulating or conductive, to maintain the geometry of the subrack.

Type 2 is extended to obviate the need for a spacer, this version is acceptable provided there is no need to insulate the backplane from the extrusion.

CONTENTS OF KIT

Description	Material/Finish
2 End plates	1,2mm CR4 steel BS 1449 zinc plate and clear passivate
2 End plate angles	Aluminium alloy BS 1474-6063-T6 anodised
2 Front extrusions	Aluminium alloy BS 1474 6063T6 conductive clear chromate
2 Top and bottom rear extrusions	Aluminium alloy conductive clear chromate
1 Two part centre rear extrusion 6U	Aluminium alloy conductive clear chromate
Fixings	
Tapped strips - backplane versions	MS zinc and passivate 2 - 3U 4 - 6U

Note: The finish gives excellent electrical conductivity but is more easily marked than anodising. During assembly care should therefore be taken to avoid the deposition of grease and oil, particularly on visible surfaces

ORDERING INFORMATION

Backplane mounting type 1

Height	End plate depth	Width (HP)	Order code
3U	180	42	956-241016 *
3U	180	60	956-241017 *
3U	180	84	956-241018 *
3U	240	42	956-241019 *
3U	240	60	956-268735 *
3U	240	84	956-241020 *
3U	360	84	956-241021 *
6U	180	42	956-241022 *
6U	180	60	956-241023 *
6U	180	84	956-241024 *
6U	240	42	956-241025 *
6U	240	84	956-241026 *
6U	360	84	956-241027 *

Backplane mounting type 2

3U	180	84	956-250499 *
3U	240	42	956-256256 *
3U	240	84	956-250500 *
3U	360	84	956-250501 *
6U	180	84	956-250502 *
6U	240	84	956-250503 *
6U	360	84	956-250504 *

DIN 41612 mounting

3U	180	84	956-241028 *
3U	240	84	956-241029 *
3U	360	84	956-241030 *
6U	180	84	956-241031 *
6U	240	84	956-241032 *
6U	360	84	956-241033 *

* Denotes minimum order quantity, please contact our sales office.

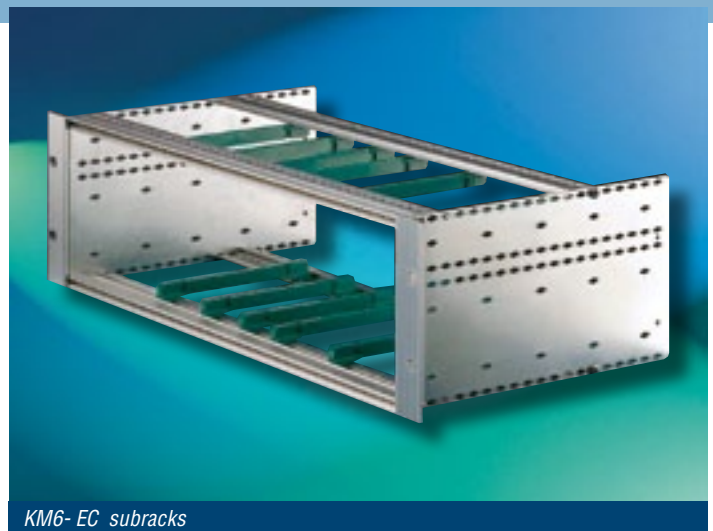

KM6-EC subracks

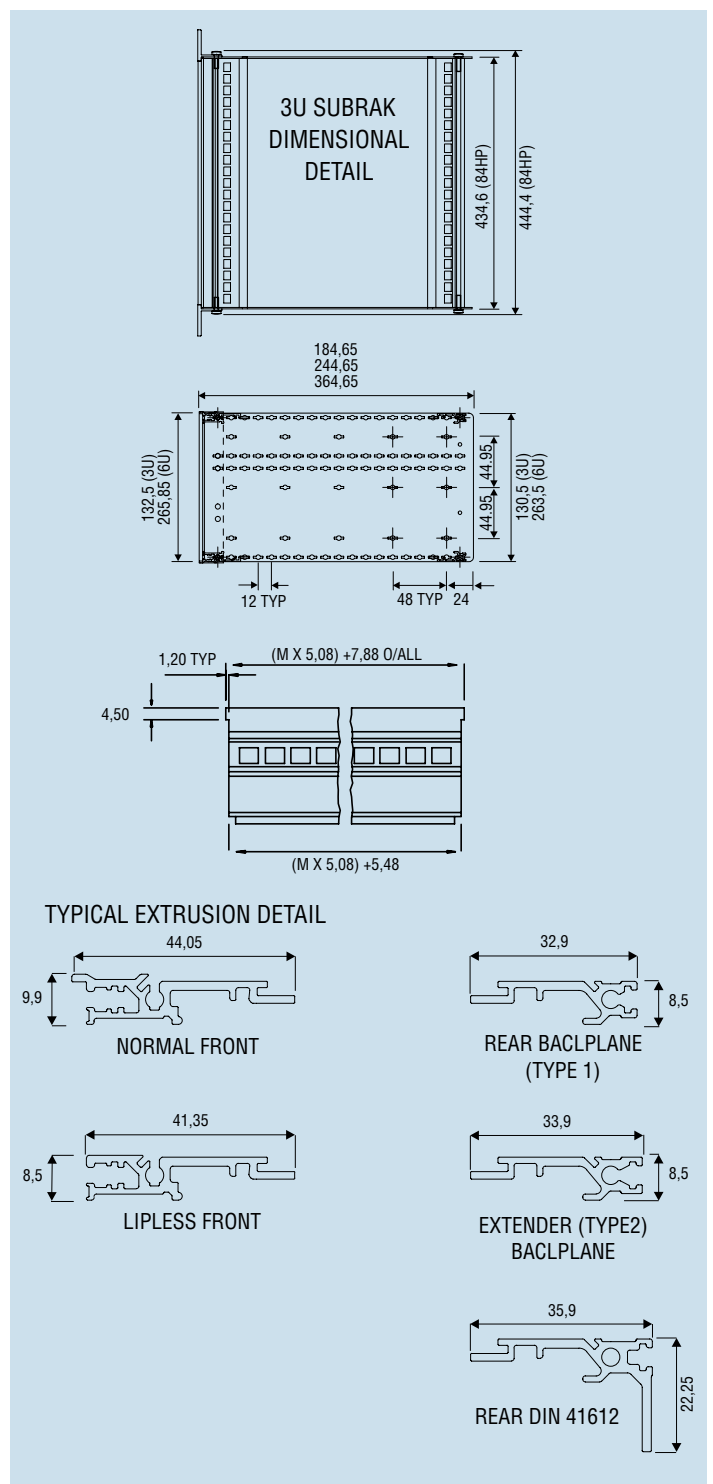

KM6-EC DIVIDER KITS

Use to partially divide 6U into 2 x 3U sections. Please note that divider plate occupies 2HP of front panel space. These kits can be used as right or left hand dividers.

Full width (2 x 3U)

There are two types of 84HP divider kits:

Type A contains normal front extrusions, with the 'eyebrow'

Type B uses a 'lipless' extrusion, which will permit the fitting of 6U flat front panels. (EMC panels would require modification to the channel section).

CONTENTS OF KIT

Item/Description	Material/Finish
Two front extrusions	Aluminium alloy BS 1474 6063 T6
Divider plate (Not 84HP versions)	1,2mm aluminium BS 1470 5251-H22 (NS4H3) Alocrom 1000 or equivalent
Fixings	
Order separately: Tapped strips	

DIVIDER KITS ORDERING INFORMATION

Width (HP)	Types	Order code
24	Mixed	956-241336 *
42	Mixed	956-241337 *
60	Mixed	956-241338 *
84	A	956-242870 *
84	B	956-242871 *

TAPPED STRIPS ORDERING INFORMATION

Width (HP)	Order code
24	950-202799
42	950-202739
60	950-202740
84	950-202001

EMC SCREENING

The 240mm and 360mm deep, 84hp versions of KM6-EC can be EMC screened by the addition of various components, some of which are KM6-II compatible. In order to screen overall a KM6-EC you will need an extrusion kit and rear closing angles that are KM6-EC specific; plus tapped strips, top and bottom covers, front and rear panels and EMC fingers from the KM6-II range.

CONTENTS OF KIT

Item/Description	Material/Finish
2 extrusion	Aluminium alloy BS 1474 6063 T6
Fixings	

Rear closing angle - order singly

Tapped strip - order singly

ORDERING INFORMATION

Description	Order code
Extrusion kit 84hp	956-242870 *
Rear closing angle 3U	956-243237 *
Rear closing angle 6U	956-243238 *

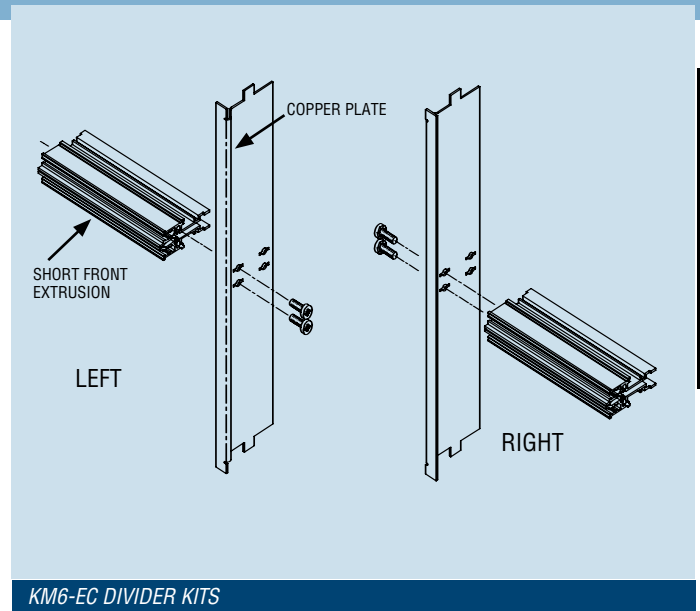

COVERS

The KM6-II covers shown on page 44 of the Handbook can be retrofitted and removed without disturbing the end plates.

A simple ventilated KM6-EC cover is also available. This cover slides between the front and rear extrusion, before fitting the second end plate, to protect the pcb area of EC subracks. The ventilation area is 35%.

CONTENTS OF KIT

Item/Description	Material/Finish
1 Cover	1mm perforated mild steel, zinc plate and passivated

ORDERING INFORMATION

Description	Order code
84HP 160mm ventilated cover	956-250292 ★
84HP 220mm ventilated cover	956-250293 ★

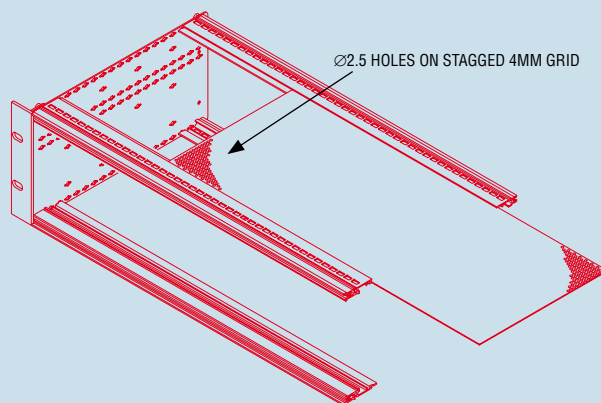

Cover

SELF ADHESIVE IDENTIFICATION LABELS

The extrusions of KM6-EC are unprinted. Where it is required to identify slot positions, self adhesive labels can be applied. The labels are printed 1 to 84 and 84 to 1 in black on yellow, on a 1HP pitch.

Supplied in multiples of 10 pairs

ORDERING INFORMATION

Description	Order code
Identification label (10 pairs)	956-245524

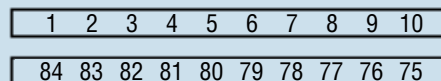

Self adhesive identification labels

TOOLKIT CAD PACKAGE

Similar to the KM6-II Toolkit CAD package, but for KM6-EC range of subracks. Available in IGES and DXF formats plus an EasyCAD2 designer version which includes the EasyCAD2 program.

The toolkit packages are supplied on 3.5" discs.

ORDERING INFORMATION

Description	Order code
D X F format	956-248818
IGES format	956-248820
Easy CAD 2 design version	956-248821